

# **WCS : Quick Install Guide**

**v.1**

# Package Contents

## Transmitter

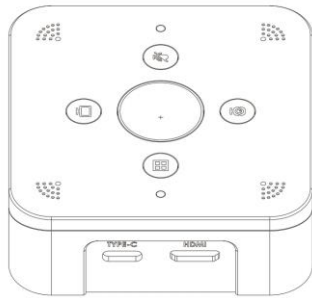

## Receiver

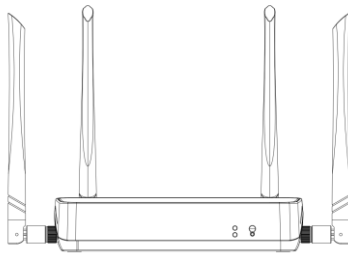

### For Type-C

Type-C Cable



### For HDMI

HDMI Cable



USB Cable



Antennas



HDMI Cable



Adapter



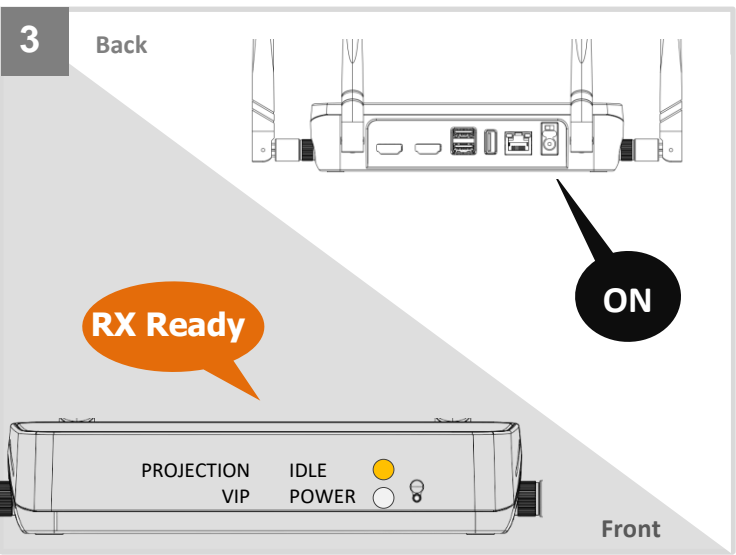
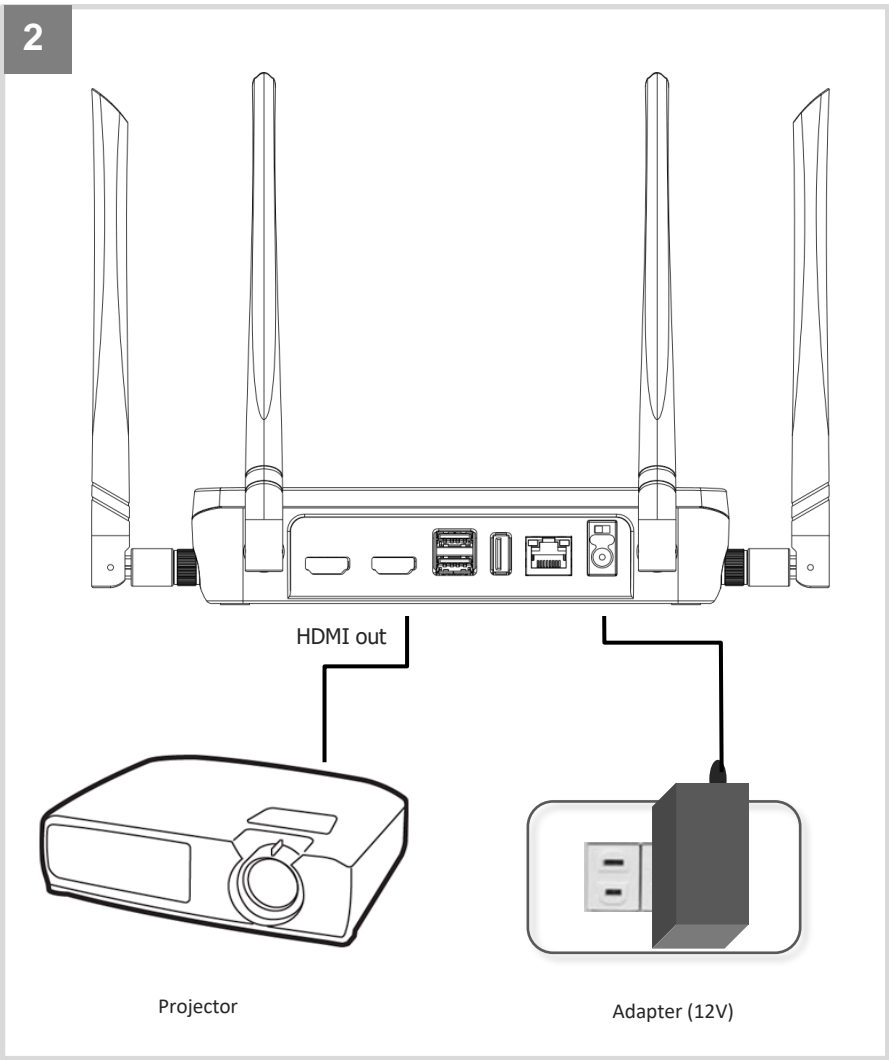
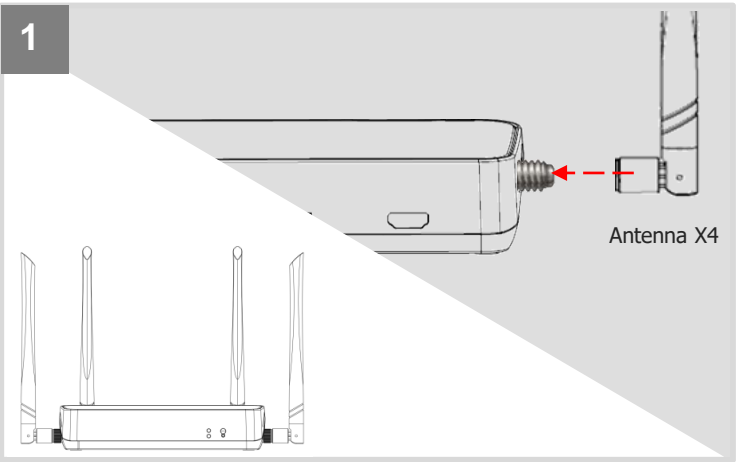

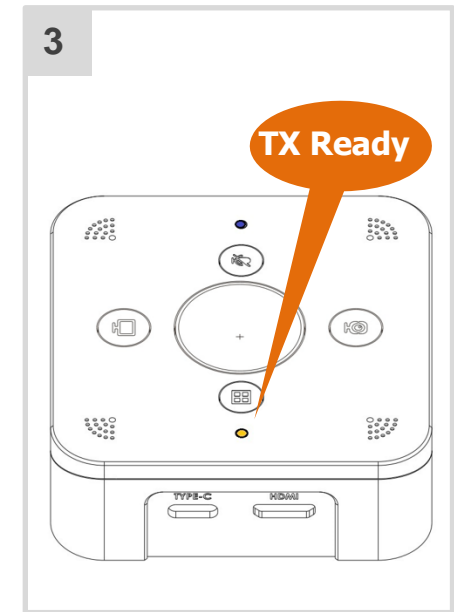
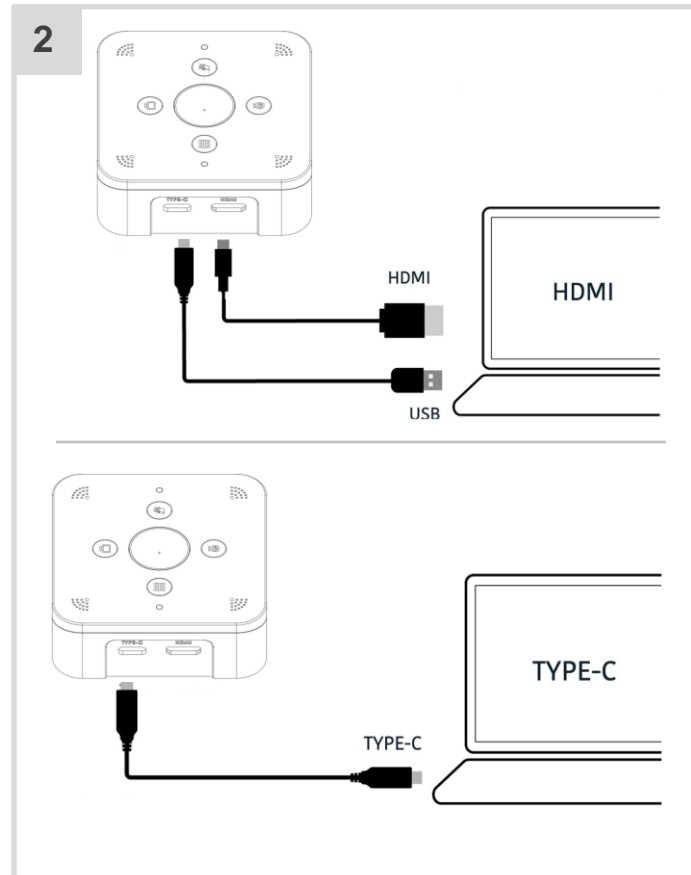
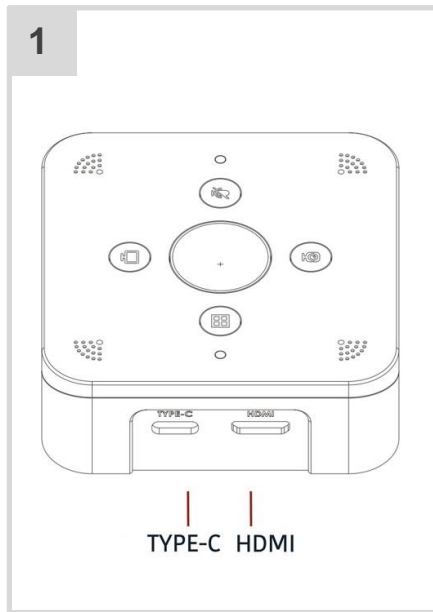

### For Type-C laptop :

- Requires USB3.1 Type-C (Display Port) or Thunderbolt™3 Type-C connector on PC
- 電腦介面需支援USB 3.1 Type-C (Display Port)或Thunderbolt™3 Type-C
- 计算机接口需支持USB 3.1 Type-C (Display Port)或Thunderbolt™3 Type-C



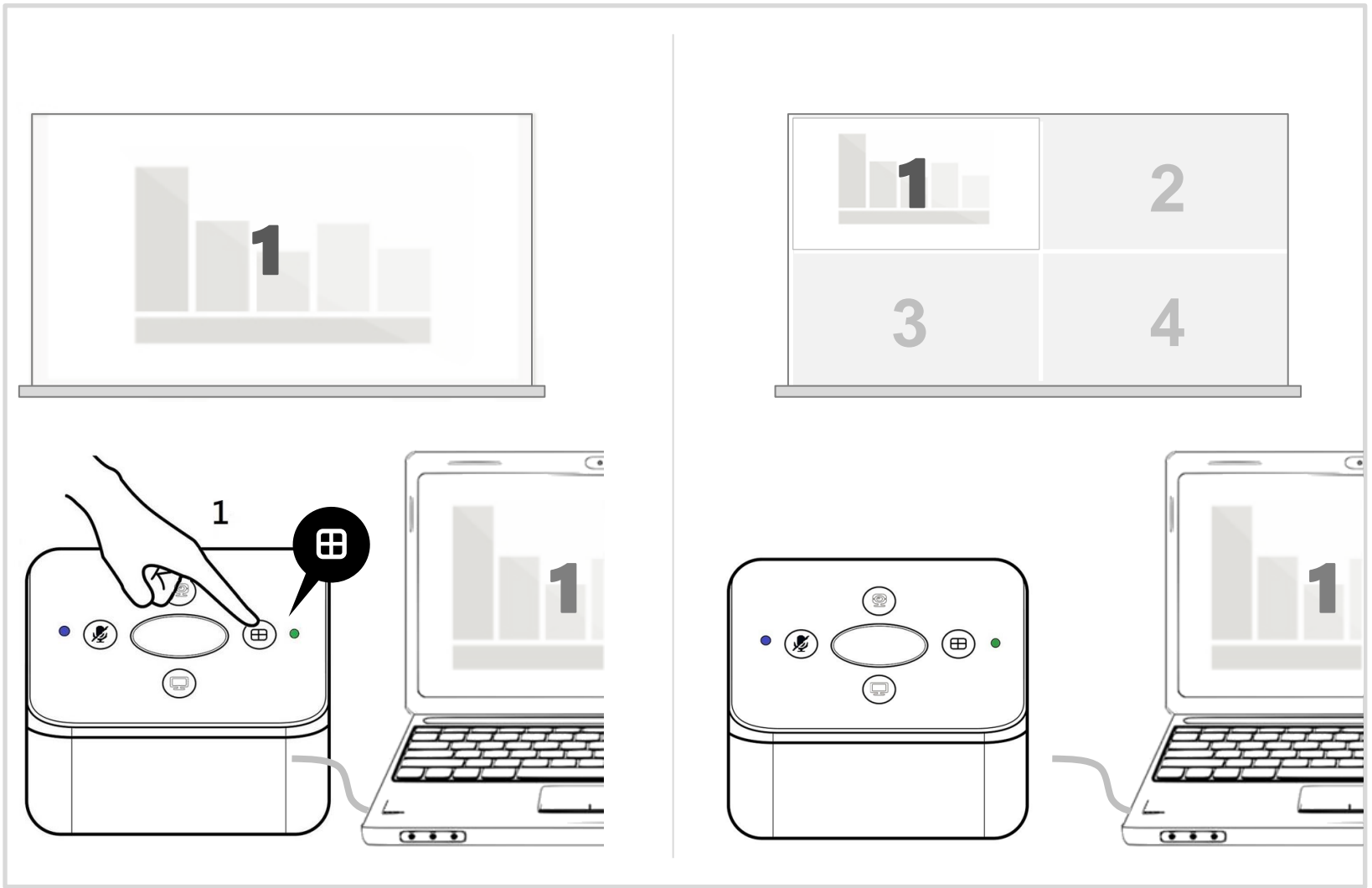

1

Open Conference Application , change Microphone to WCS-4000 Tx Microphone



Setting > Microphone  
**WCS-4000 TX Microphone**

使用WiFi Mic 功能可將所有WCS4000T 上的 Mic功能同時多點拉回到會議軟體上使用



1

Open Conference Application , change camera to WCS-4000 Camera



Setting > Camera  
WCS-4000-Camera

2

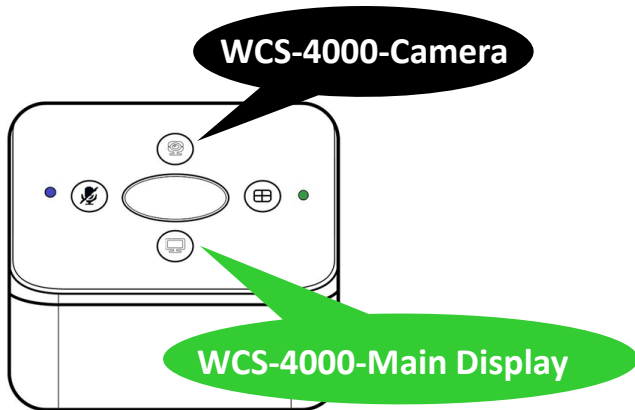

使用WiFi UVC 功能可將連接在WCS-4000R 上的**USB CAM** 或是正在投影的WCS-4000T **畫面(Main Display)** 拉回到會議軟體上使用

WCS-4000-Main Display

WCS-4000-Camera

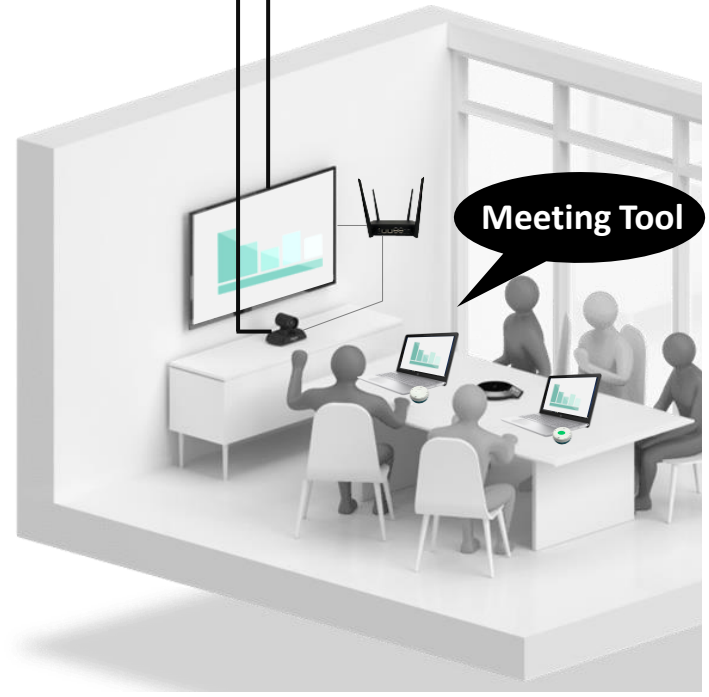



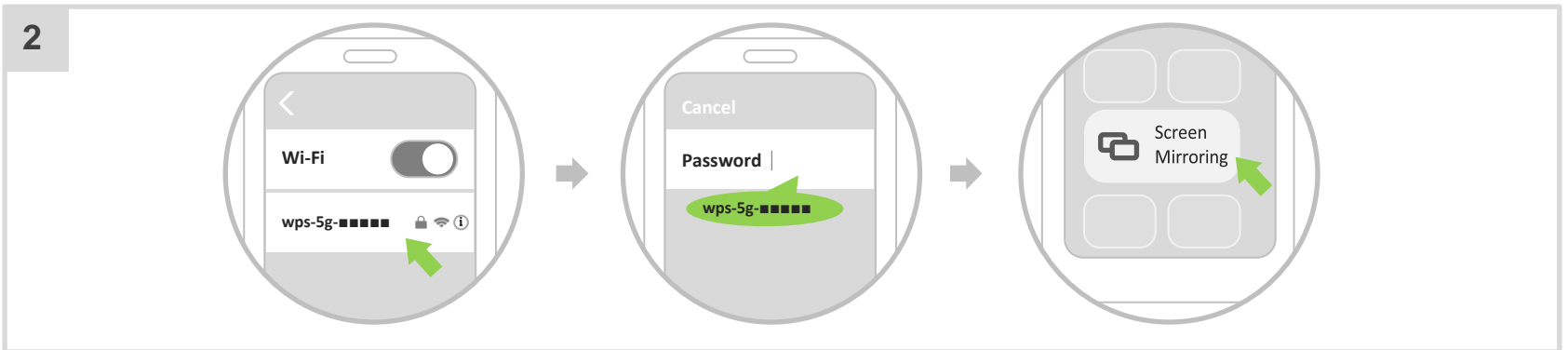
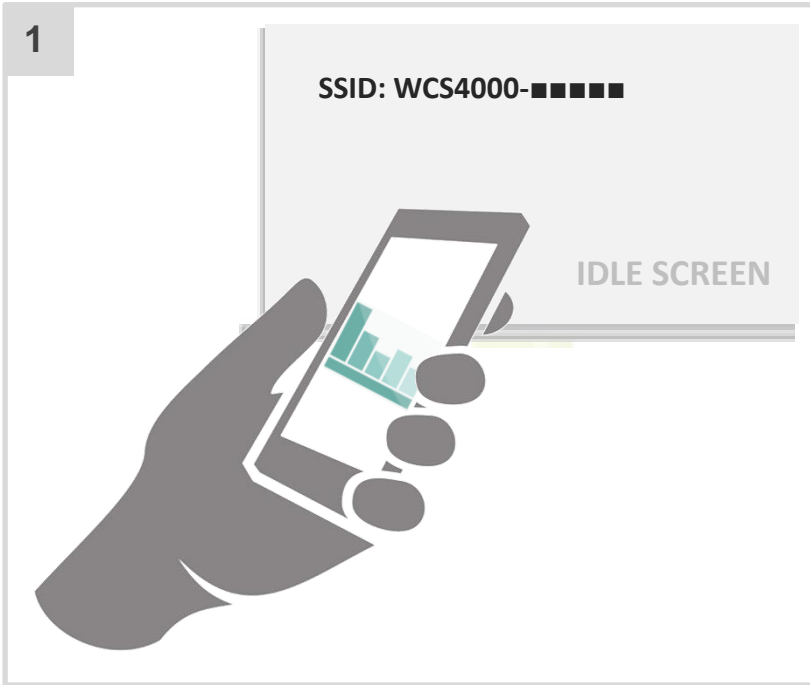

1

Settings > Display > Miracast. (As usual, this might vary a bit depending on your device.)

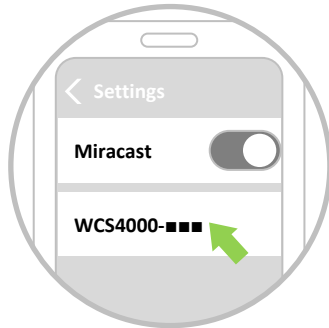

2



# Appendix

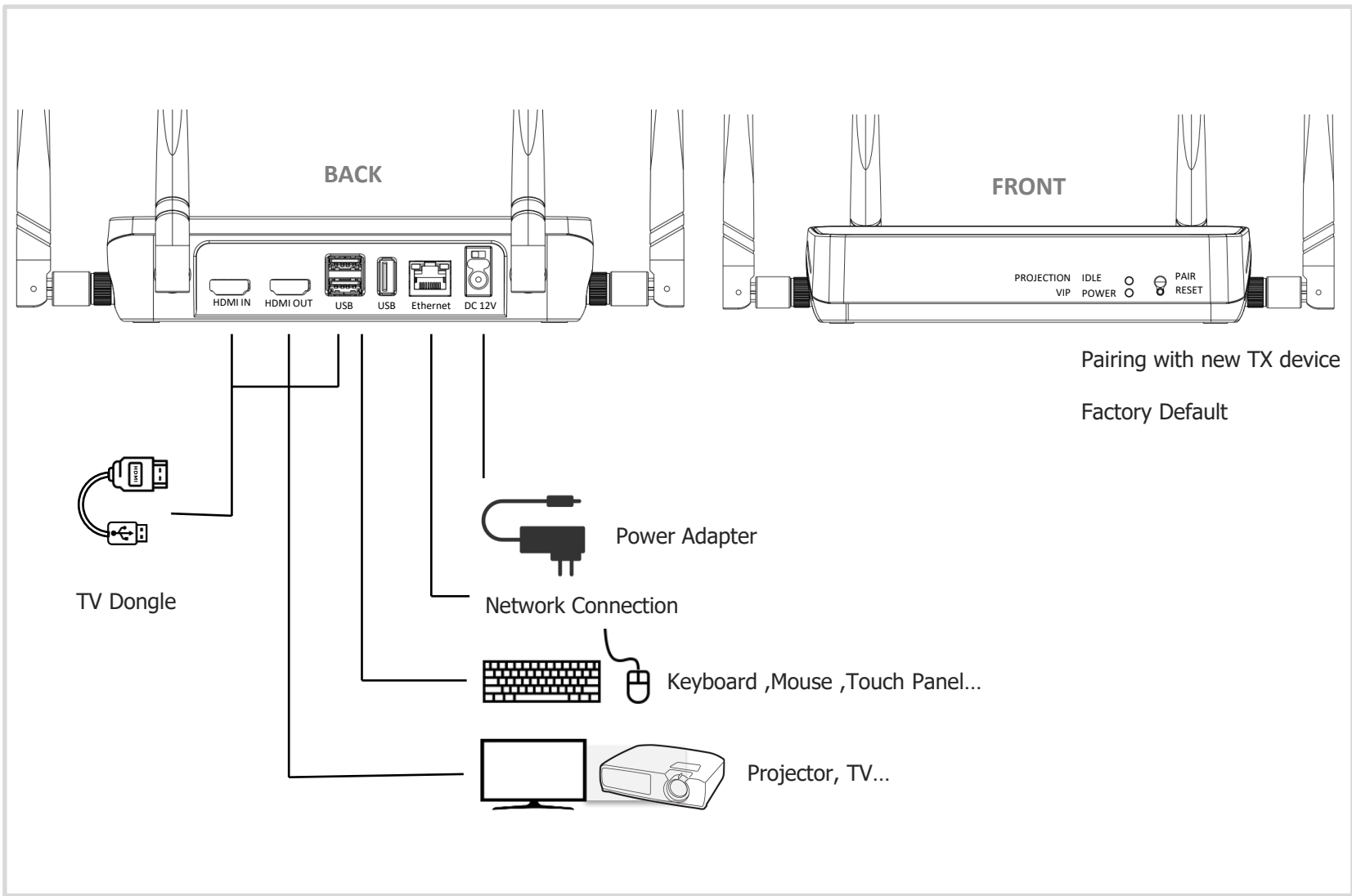

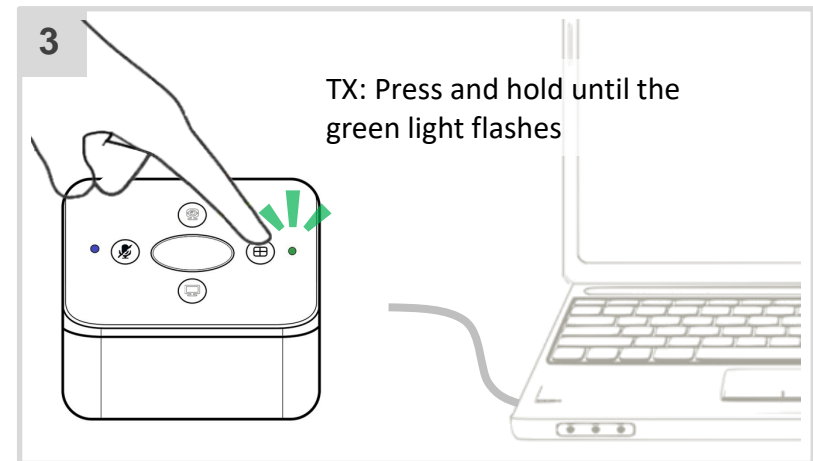
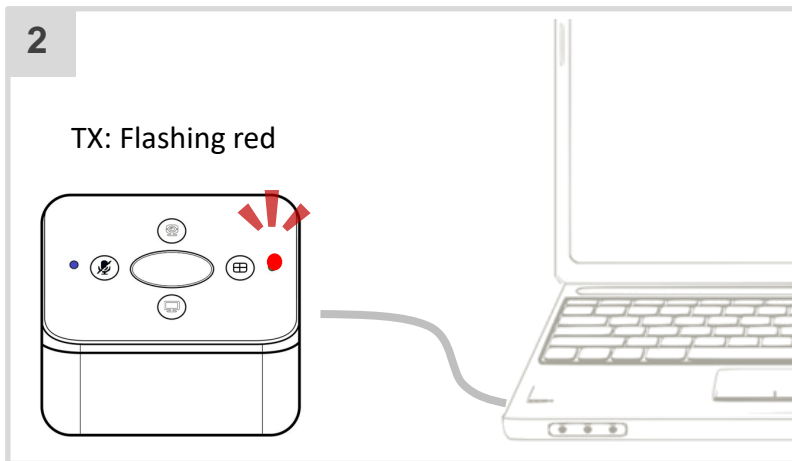
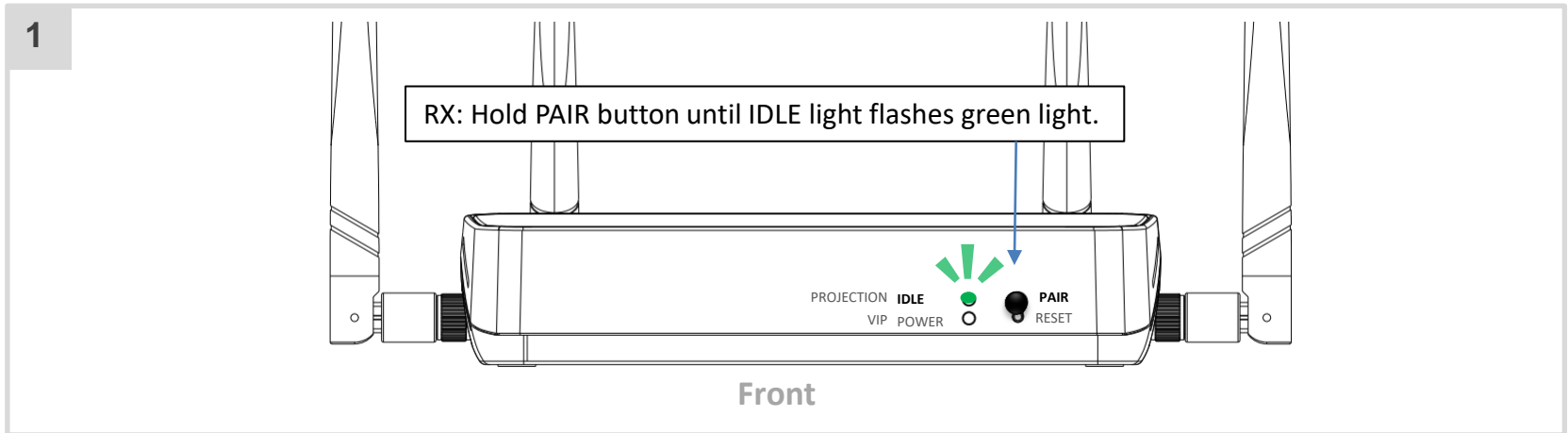

- If you have purchased additional TX unit(s), please pair them with your RX by following this simple process.
- 當購入新的發送器(TX),請依照步驟將其與原有的接收器(RX)配對。
- 当购入新的发送器(TX),请依照步骤将其与原有的接收器(RX)配对。

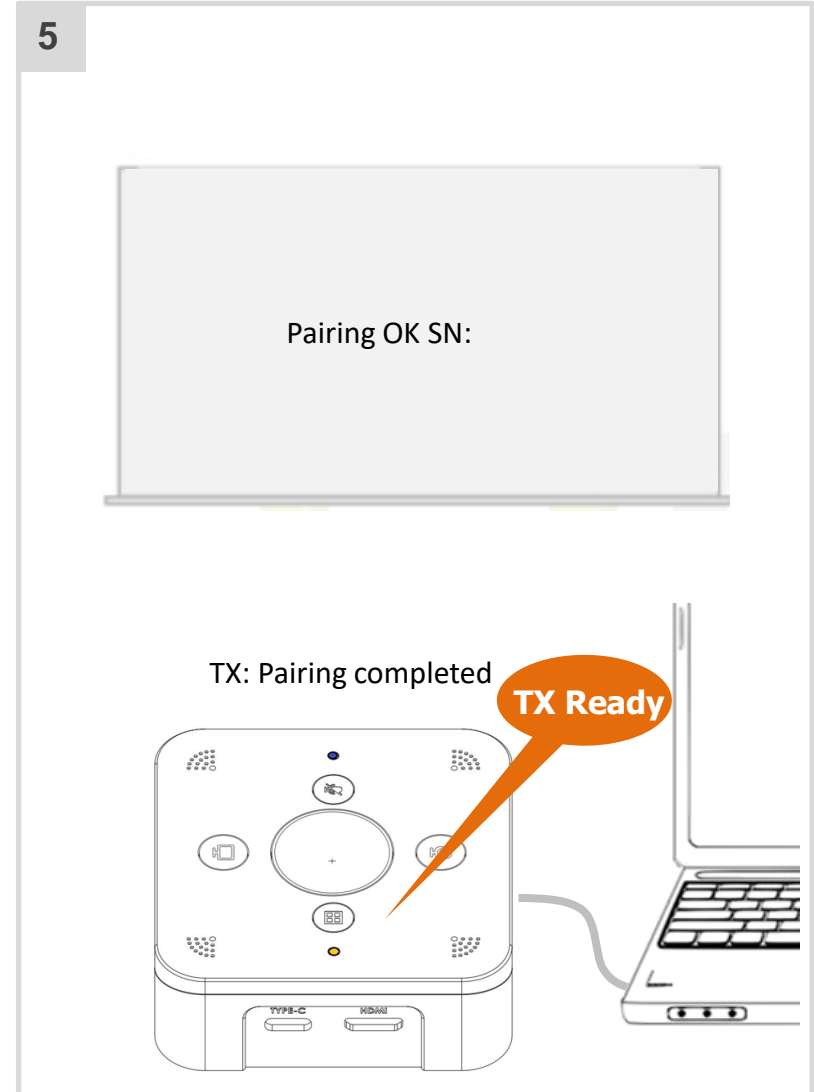
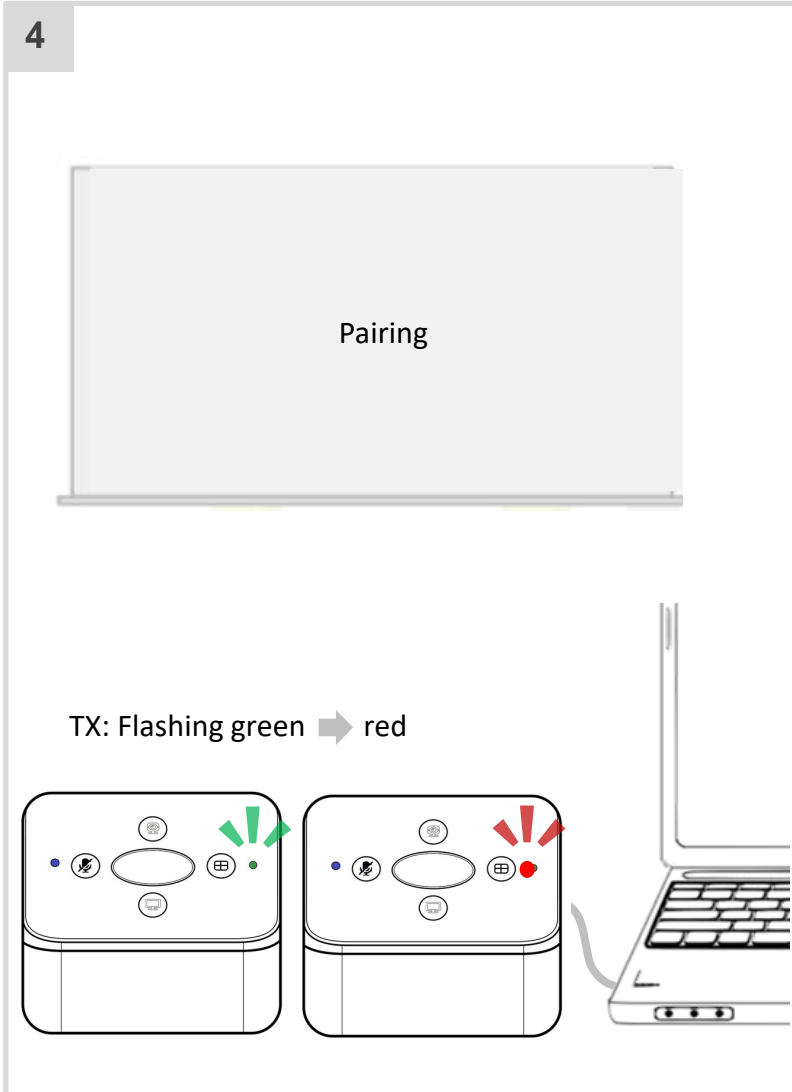

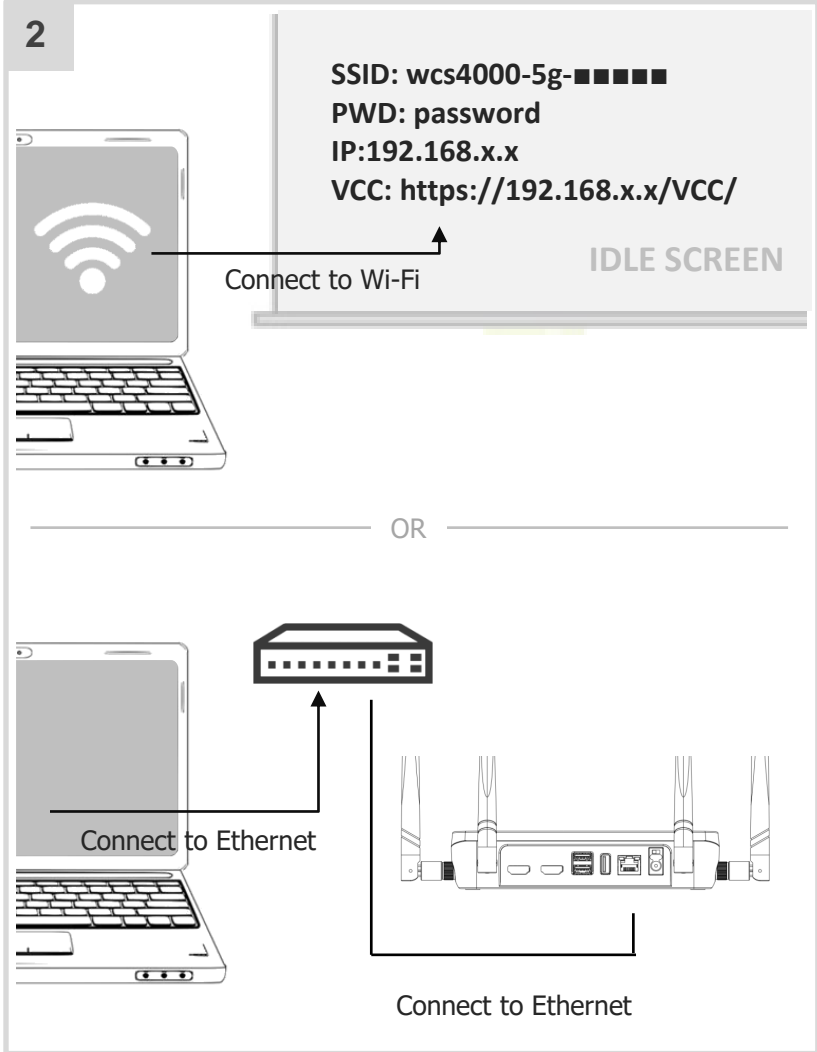
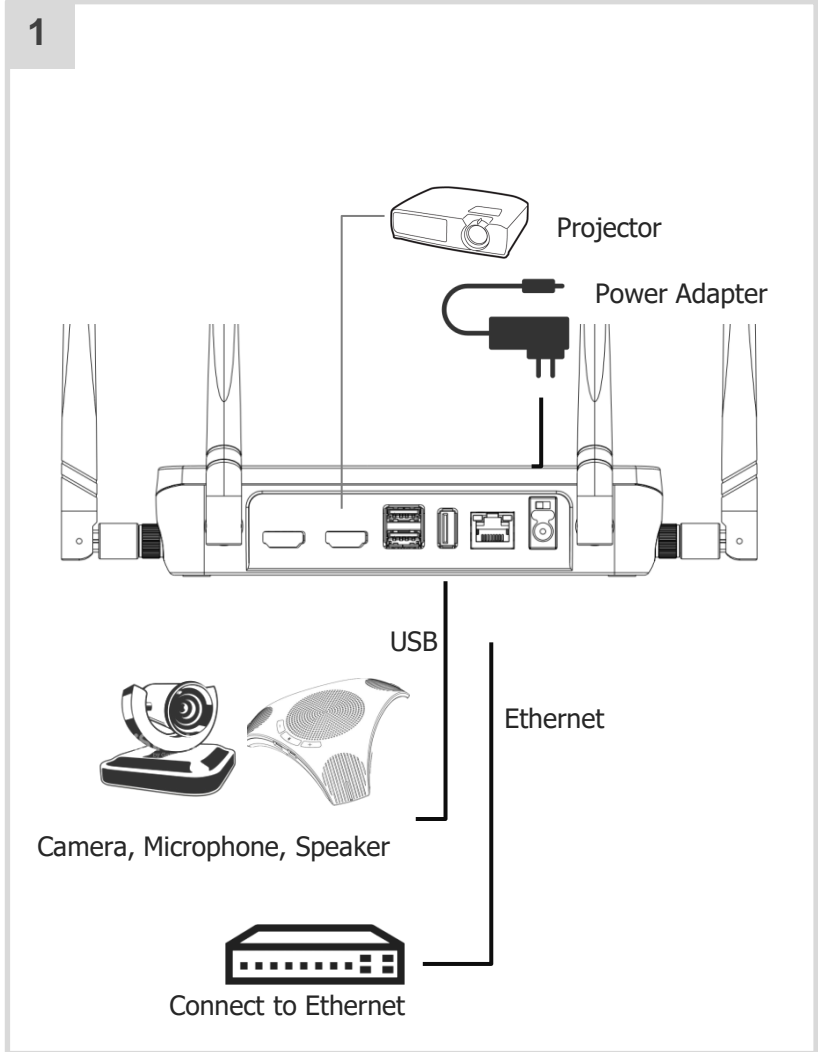

3

Install VCC Application  
On idle Screen VCC link  
(win10 or 11)

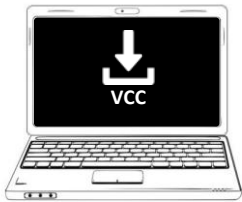

Search and connect to VCS

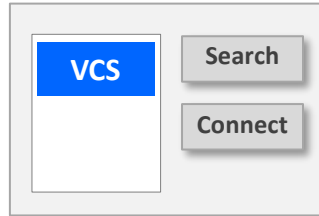

4

Open Conference Application , change camera or  
Audio to VCS's

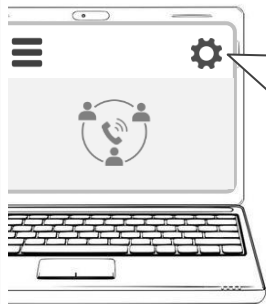

Setting > Microphone / Speaker  
**VCS-Audio**

Setting > Camera  
**VCS-CAM**  
**VCS-Main Display**

